

SWISS⁺
TECHNOLOGY

NABM SERIES BALL VALVE ACTUATOR

**Modulating Control
10 Nm**

NENUTE[®]EC

INNOVATIVE MEMBER OF SWIS⁺TEC

www.nenutec.info

NABM SERIES BALL VALVE ACTUATOR

Modulating Control
10 Nm



NABM...10 HN (S1) SERIES

NABM series standard valve actuators are especially designed and produced for applications in the HVAC systems. Our wide range of standard valve actuators has been developed to operate and position ball valves of different sizes.

PRODUCT FEATURE

- Torque 10 Nm
- Valve size DN40(1½") / DN50(2")
- Power supply AC/DC 24 V / AC2 30V
- Control Modulating DC 0(2)...10 V & DC 0(4)...20 mA
- Shaft dimensions - □ 9.0 mm (fixed)
- Selectable direction of rotation of reversing actuator
- Actuator with 1 m cable connection
- Optional 1 Adjustable SPDT auxiliary switch

MODEL SELECTION TABLE

MODEL / TYPE	TORQUE	POWER SUPPLY	RUNNING TIME	AUXILIARY SWITCH
NABM 1.1-10 HN	10 Nm	AC/DC 24 V ± 10%	100...150 sec	-
NABM 1.1-10S1 HN	10 Nm	AC/DC 24 V ± 10%	100...150 sec	1 x SPDT (Adjustable)

DIMENSION (mm)

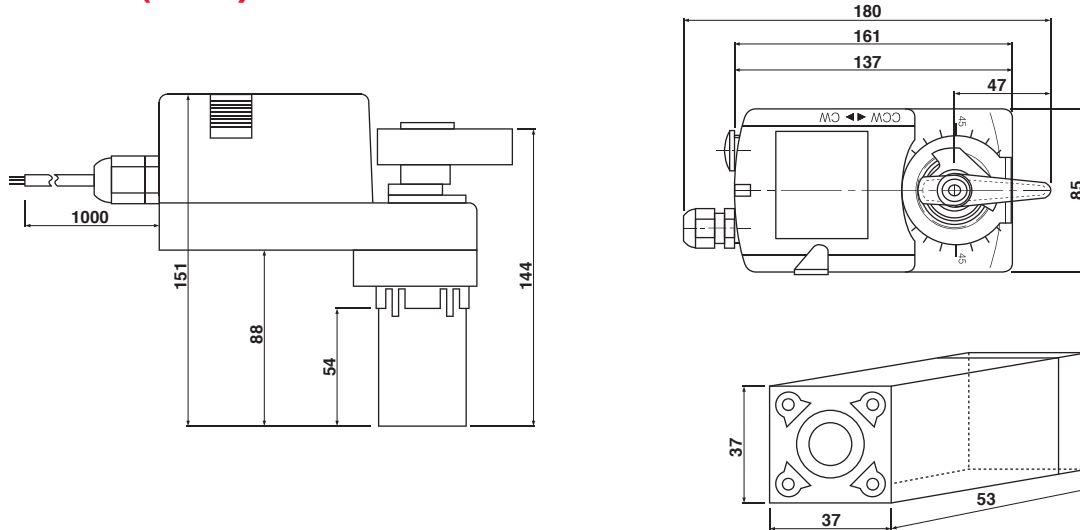

TECHNICAL SPECIFICATION

MODEL NUMBER	NABM 1.1-10 (S1) HN
TORQUE	10 Nm
VALVE SIZE	DN40(1½") / DN50(2")
SHAFT DIMENSION	□ 9.0 mm (fixed)
POWER SUPPLY	AC/DC 24 V ± 10%
FREQUENCY	50...60 Hz
CONTROL SIGNAL (INPUT)	DC 0(2)...10 V / 0(4)...20 mA
POSITION SIGNAL (OUTPUT)	DC 0...10 V
POWER CONSUMPTION	
● OPERATING	6.0 W
● END POSITION	4.0 W
FOR WIRE SIZING	6.5 VA
ELECTRICAL CONNECTION	1 m Cable
AUXILIARY SWITCH RATING	3 (1.5) A, AC 250 V
PROTECTION CLASS	Class III ⚡
ANGLE OF ROTATION	90° (95° mechanical)
WEIGHT	< 1.1 Kg
LIFE CYCLE	60,000 Rotation
SOUND LEVEL	40 dB
IP PROTECTION	IP54
OPERATING TEMPERATURE	-20°...50° as per IEC 721-3-3
NON-OPERATING TEMPERATURE	-30°...+60° C / IEC 721-3-2
AMBIENT HUMIDITY	5%...95% rH non condensing / EN
MAINTENANCE	Maintenance Free
MODE OF OPERATION	Type I / EN 60730-1
EMC	CE & ISO 9000 EN / EEC

NABM SERIES BALL VALVE ACTUATOR

Modulating Control
10 Nm

WIRING DIAGRAM NABM...10 (S1) HN POWER SUPPLY AC/DC 24V

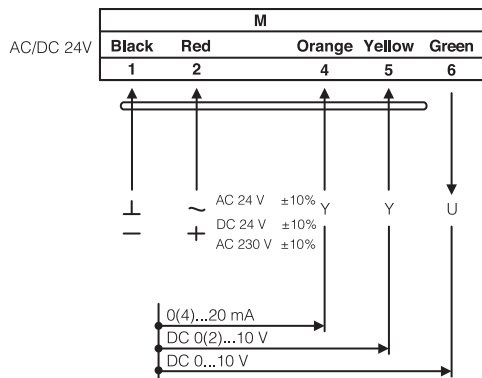

DIRECTION OF ROTATION NABM...10 (S1) HN

Default factory setting: CCW.

Direction of rotation can be change by toggling between CW/CCW switch on the actuator's housing.

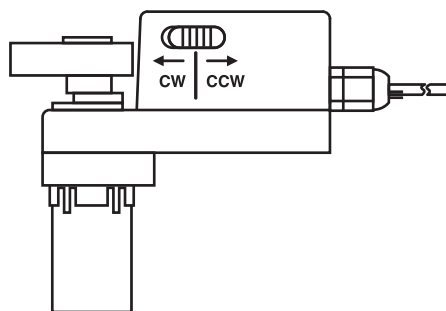

WIRING DIAGRAM NABM...10 (S1) HN AUXILIARY SWITCH

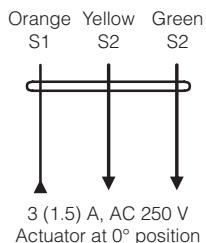
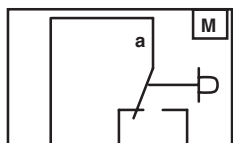

AUXILIARY SWITCH NABM...10 (S1) HN

Switch **a** factory-set at 5°.

The auxiliary switch can be optimally adjusted between 0°...90°.

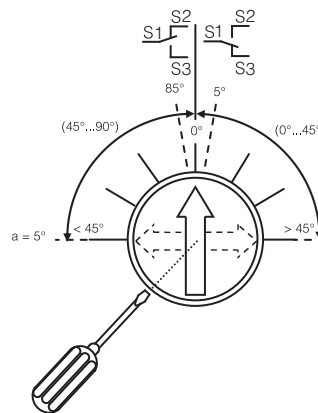

WIRING DIAGRAM NABM...10 (S1) HN PARALLEL CONNECTION

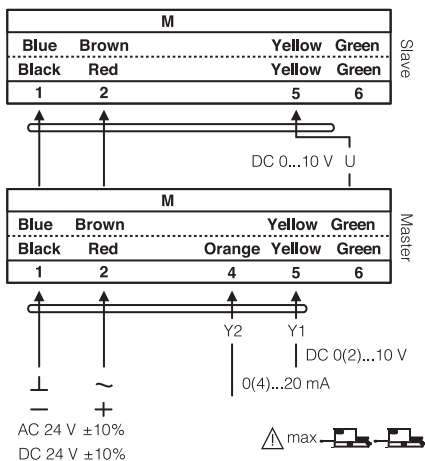

REMARK

During parallel operation, the output signal (terminal 6, DC 0...10 V) of the master actuator must be connected to terminal 5 of the next slave actuator.

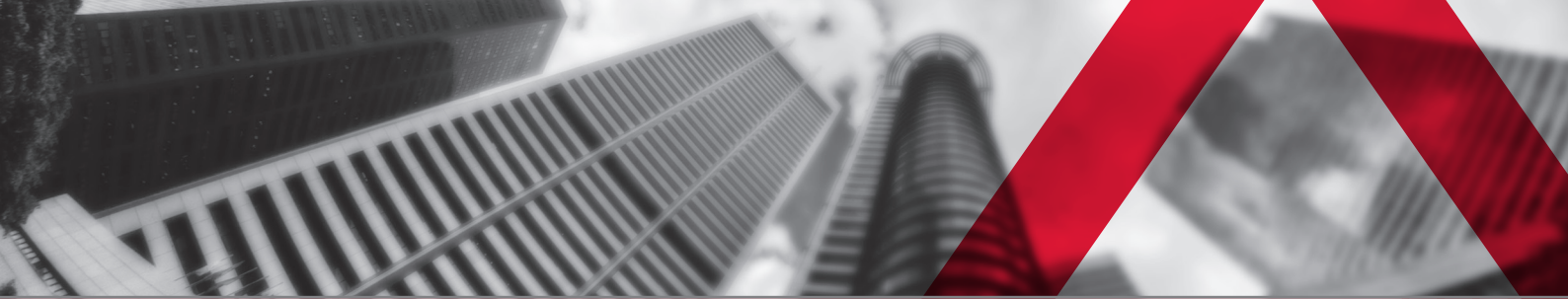

MIXING CLOSED

MIXING OPEN

ACTUATOR POSITION

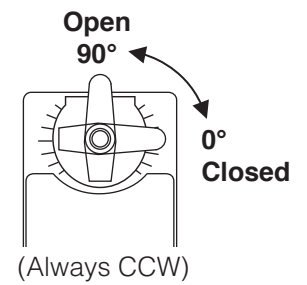
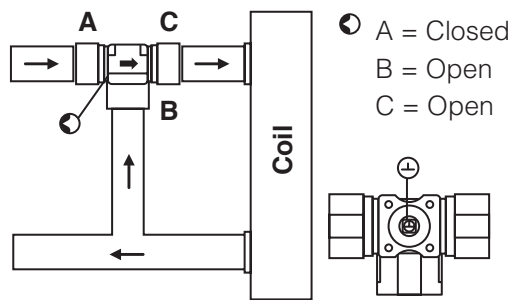
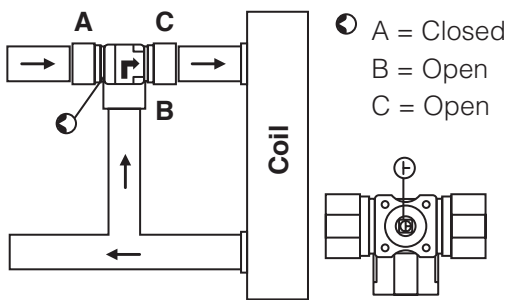

2-way Closed 2-way Open

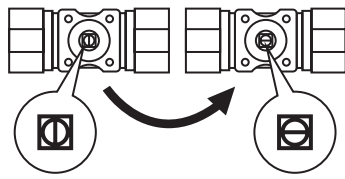

3-way Closed 3-way Open

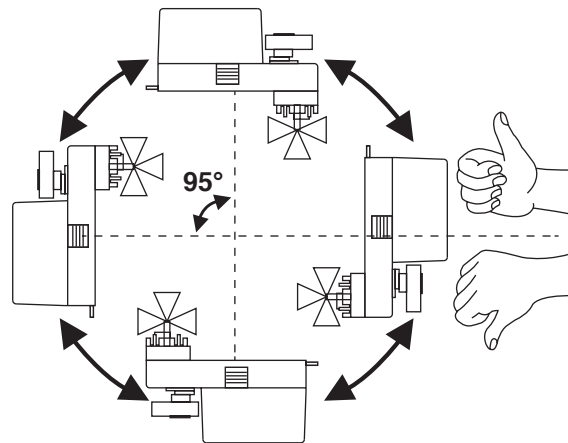
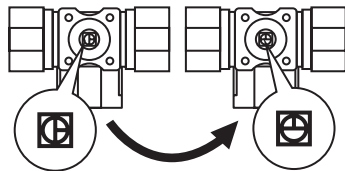

IMPORTANT REMARK

For special requirement, consult your local Nenutec's representative.

This actuator includes electrical and electronic components and may not be disposed as household garbage. Please consider the local valid legislation.

AC / DC 24 V: Connect via safety isolating transformer.
 AC 230 V: To isolate from the main power supply, the system must incorporate a device which disconnects the phase conductor (with at least a 3mm contact gap.)

The performance specifications are nominal and conform to acceptable industry standards. NENUTEC shall not be liable for damages resulting from misapplication or misuse of its products.