

SWISS⁺
TECHNOLOGY

NACM SERIES **STANDARD DAMPER ACTUATOR**











Modulating Control
10 Nm

NENUTE[®]EC

INNOVATIVE MEMBER OF SWIS⁺TEC

www.nenutec.info

DAMPER ACTUATOR MODEL CHART

MODEL	 NACA	 NACM	 NECA	 NECM	 NASA	 NASM	 NAFA	 SAFA	 SASA	 NSVA
VOLTAGE 230VAC ~ 24VAC/DC	●	●	●	●	●	●	●	●	●	24 VAC
TORQUE (NM)	2 ; 5 ; 10 ; 20 ; 40	2 ; 5 ; 10 ; 20 ; 40	5 ; 10 ; 20	5 ; 10 ; 20	10 ; 20	10 ; 20	3 ; 5 ; 8 ; 20	3 ; 5 ; 8 ; 20	10 ; 15	5
CONTROL	2/3 pts	Modulating	2 pts	Modulating	2/3 pts	Modulating	2 pts SR	2 pts SR	3 pts	Modulating
SPECIAL TYPE										
ELECTRONIC RETURN			●	●						
FAST RUNNING					●	●			●	
SPRING RETURN							●			
FIRE & SMOKE SPRING RETURN								●		
SMOKE SAFETY								●	●	
NETWORKING										●

TYPE DESIGNATION

TYPE	ACTUATOR	DESIGNATION	CONTROL	VOLTAGE	DOT	INPUT SIGNAL	HYPHENATED	TOUQUE	AUXILIARY SWITCH
N	A	C	M	1	.	1	-	1 0	S1

TYPE	N = Standard Actuator S = Fire & Smoke
ACTUATOR	A = Standard Actuator E = Electronic Return
DESIGNATION	C = Standard Actuator S = Fast Running Actuator F = Spring Back Actuator
CONTROL	A = 2/3 Points M = Modulating
VOLTAGE	1 = 24 VAC/VDC 2 = 230 VAC 3 = 110/120 VAC 4 = 48 VAC

INPUT SIGNAL (NOT APPLICABLE FOR 2/3 POINTS)	1 = 0(2)...10 VDC and 0(4)...20 mA 2 = 0(2)...10 VDC only 3 = 0...135 Ω only 4 = 4...20 mA only
TORQUE	02 = 2 Nm 03 = 3 Nm 05 = 5 Nm 08 = 8 Nm 10 = 10 Nm 15 = 15 Nm 20 = 20 Nm 40 = 40 Nm
AUXILIARY SWITCH / FEEDBACK POTENTIOMETER	None = No Auxiliary or Feedback Potentiometers S1 = 1 x Auxiliary Switch S = 2 x Auxiliary Switches P1 = 1000Ω P2 = 10000Ω P3 = 140Ω

NACM SERIES STANDARD DAMPER ACTUATOR

Modulating Control
10 Nm

NACM...10 (S1) SERIES

NACM standard damper actuators are specially designed and produced for applications in the HVAC Systems. Our wide range of Nenutec standard damper actuators has been developed to operate and position air dampers of different sizes.



PRODUCT FEATURE

- Torque 10 Nm
- Damper size 2.0 m²
- Power supply AC/DC 24V and AC 230 V
- Modulating Control Signal DC 0(2)...10 V / 0(4)...20 mA
- Shaft dimensions - Ø 10...20 mm / □ 5...14 mm
- Minimum Shaft Length 45 mm
- Adjustable angle of rotation
- Selectable direction of rotation of reversing actuator
- Actuator with 1 m cable connection
- Optional 1 Adjustable SPDT auxiliary switch
- Manual Over-ride push button when required

MODEL SELECTION TABLE

MODEL / TYPE	TORQUE	POWER SUPPLY	RUNNING TIME	AUXILIARY SWITCH
NACM 1.1-10	10 Nm	AC/DC 24 V ± 10%	70...100 sec	-
NACM 1.1-10S1	10 Nm	AC/DC 24 V ± 10%	70...100 sec	1 x SPDT (Adjustable)
NACM 2.2-10	10 Nm	AC 230 V ± 10%	70...100 sec	-

DIMENSION (mm)

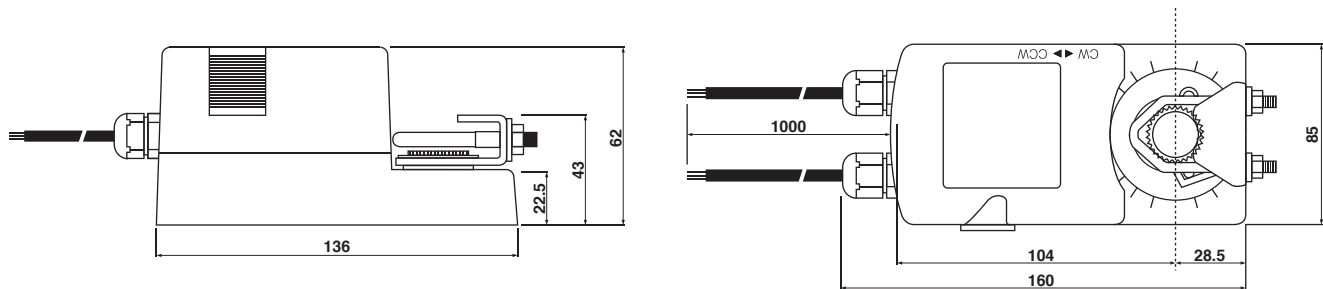

TECHNICAL SPECIFICATION

MODEL NUMBER	NACM 1.1...10 (S1)	NACM 2.2...10 (S1)
TORQUE	10 Nm	10 Nm
DAMPER SIZE	2.0 m ²	2.0 m ²
SHAFT DIMENSION	Ø 10...20 mm / □ 5...14 mm	Ø 10...20 mm / □ 5...14 mm
POWER SUPPLY	AC/DC 24 V ± 10%	AC 230 V ± 10%
FREQUENCY	50...60 Hz	50...60 Hz
CONTROL SIGNAL (INPUT)	DC 0(2)...10 V / 0(4)...20 mA	DC 0(2)...10 V
POSITION SIGNAL (OUTPUT)	DC 0...10 V	DC 0...10 V
POWER CONSUMPTION		
● OPERATING	6.0 W	6.0 W
● END POSITION	2.0 W	2.0 W
FOR WIRE SIZING	6.5 VA	6.5 VA
ELECTRICAL CONNECTION	1 m Cable	1 m Cable
AUXILIARY SWITCH RATING	3 (1.5) A, AC 250 V	3 (1.5) A, AC 250 V
PROTECTION CLASS	Class III ⚡	Class II ⚡
ANGLE OF ROTATION	90° (95° mechanical)	90° (95° mechanical)
WEIGHT	< 1.0 Kg	< 1.0 Kg
LIFE CYCLE	60,000 Rotation	60,000 Rotation
SOUND LEVEL	40 dB	40 dB
IP PROTECTION	IP54	IP54
OPERATING TEMPERATURE	-20°...50° as per IEC 721-3-3	-20°...50° as per IEC 721-3-3
NON-OPERATING TEMPERATURE	-30°...+60° C / IEC 721-3-2	-30°...+60° C / IEC 721-3-2
AMBIENT HUMIDITY	5%...95% rH non condensing / EN	5%...95% rH non condensing / EN
MAINTENANCE	Maintenance Free	Maintenance Free
MODE OF OPERATION	Type I / EN 60730-1	Type I / EN 60730-1
EMC	CE & ISO 9000 EN / EEC	CE & ISO 9000 EN / EEC

NACM SERIES STANDARD DAMPER ACTUATOR

Modulating Control
10 Nm

WIRING DIAGRAM NACM...10 (S1) POWER SUPPLY AC/DC 24V - AC 230V

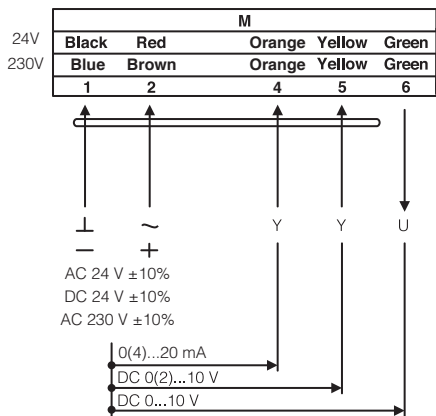

DIRECTION OF ROTATION NACM...10 (S1)

Default factory setting: CW.

Direction of rotation can be change by toggling between CW/CCW switch on the actuator's housing.

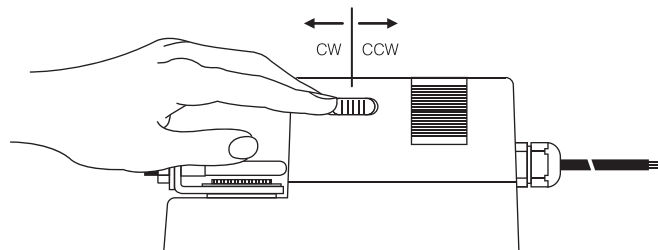

WIRING DIAGRAM NACM...10 (S1) AUXILIARY SWITCH

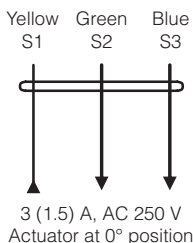
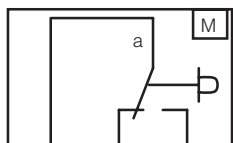

AUXILIARY SWITCH NACM...10 (S1)

Switch **a** factory-set at 5°.

The auxiliary switch can be optimally adjusted between 0°...90°.

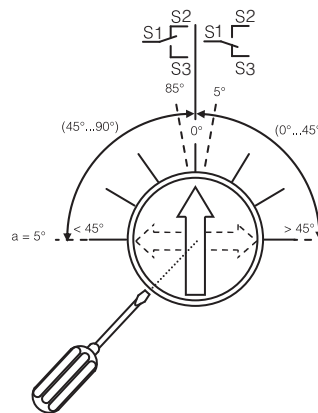

WIRING DIAGRAM NACM...10 (S1) PARALLEL CONNECTION

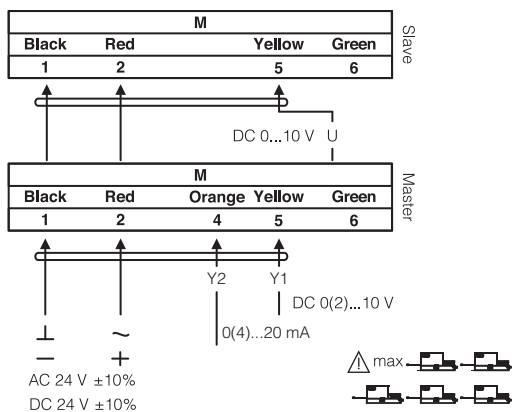

REMARK

During parallel operation, the output signal (terminal 6, DC 0...10 V) of the master actuator must be connected to terminal 5 of the next slave actuator.

ADJUSTING CONTROL SIGNALS NACM...10 (S1)

Control Signal 5 DC 0...10V
Input Resistance Ri100k Ohm

Factory Default Setting

Control Signal 5 DC 2...10V
Input Resistance Ri500k Ohm

On Request

LIMITING ANGLE OF ROTATION NACM...10 (S1)

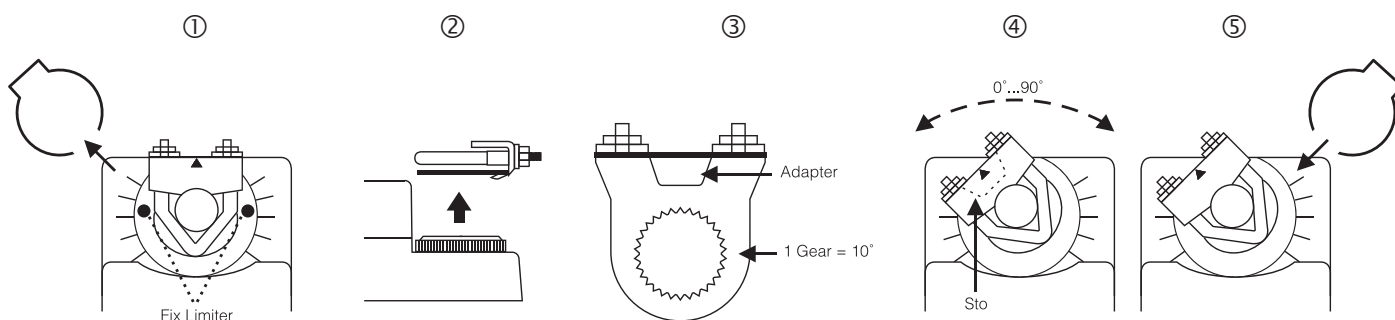

IMPORTANT REMARK

For special requirement, consult your local NenuTec's representative.



This actuator includes electrical and electronic components and may not be disposed as household garbage. Please consider the local valid legislation.



AC / DC 24 V:
AC 230 V:

Connect via safety isolating transformer.

To isolate from the main power supply, the system must incorporate a device which disconnects the phase conductor (with at least a 3mm contact gap.)

The performance specifications are nominal and conform to acceptable industry standards. NenuTec shall not be liable for damages resulting from misapplication or misuse of its products.