

# SAFA SERIES FIRE & SMOKE DAMPER ACTUATOR

2 Point Spring Return Control  
8 Nm

# NENUTEC<sup>®</sup>

INNOVATIVE MEMBER OF SWISSTECH

**NENUTEC ASIA PACIFIC PTE LTD**  
7030 Ang Mo Kio Ave 5  
#03-56 Northstar @ AMK  
Singapore 569 880













 (65) 6570 3233

 (65) 6570 6783

 [info@nenutec.com.sg](mailto:info@nenutec.com.sg)

## DAMPER ACTUATOR MODEL CHART

| MODEL                        |  NACA |  NACM |  NECA |  NECM |  NASA |  NASM |  NAFA |  SAFA |  SASA |  NSVA |
|------------------------------|--|--|--|--|--|--|--|--|--|--|
| VOLTAGE<br>230VAC ~ 24VAC/DC | ●  | ●  | ●  | ●  | ●  | ●  | ●  | ●  | ●  | 24 VAC   |
| TORQUE (NM)                  | 2 ; 5 ; 10 ;<br>20 ; 40  | 2 ; 5 ; 10 ;<br>20 ; 40  | 5 ; 10 ; 20  | 5 ; 10 ; 20  | 10 ; 20  | 10 ; 20  | 3 ; 5 ;<br>8 ; 20  | 3 ; 5 ;<br>8 ; 20  | 10 ; 15  | 5  |
| CONTROL                      | 2/3 pts  | Modulating   | 2 pts  | Modulating   | 2/3 pts  | Modulating   | 2 pts SR   | 2 pts SR   | 3 pts  | Modulating   |
| SPECIAL TYPE                 |  |  |  |  |  |  |  |  |  |  |
| ELECTRONIC RETURN            |  |  | ●  | ●  |  |  |  |  |  |  |
| FAST RUNNING                 |  |  |  |  | ●  | ●  |  |  | ●  |  |
| SPRING RETURN                |  |  |  |  |  |  | ●  |  |  |  |
| FIRE & SMOKE SPRING RETURN   |  |  |  |  |  |  |  | ●  |  |  |
| SMOKE SAFETY                 |  |  |  |  |  |  |  | ●  | ●  |  |
| NETWORKING                   |  |  |  |  |  |  |  |  |  | ●  |

## TYPE DESIGNATION

| TYPE | ACTUATOR | DESIGNATION | CONTROL | VOLTAGE | DOT | INPUT SIGNAL | HYPHENATED | TOUQE | AUXILIARY SWITCH |
|------|----------|-------------|---------|---------|-----|--------------|------------|-------|------------------|
| N    | A        | C           | M       | 1       | .   | 1            | -          | 1 0   | S1               |

|                    |                           |
|--------------------|---------------------------|
| <b>TYPE</b>        | N = Standard Actuator     |
|                    | S = Fire & Smoke          |
| <b>ACTUATOR</b>    | A = Standard Actuator     |
|                    | E = Electronic Return     |
| <b>DESIGNATION</b> | C = Standard Actuator     |
|                    | S = Fast Running Actuator |
|                    | F = Spring Back Actuator  |
| <b>CONTROL</b>     | A = 2/3 Points            |
|                    | M = Modulating            |
| <b>VOLTAGE</b>     | 1 = 24 VAC/VDC            |
|                    | 2 = 230 VAC               |
|                    | 3 = 110/120 VAC           |
|                    | 4 = 48 VAC                |

|   |   |            |
|---|---|------------|
| <b>INPUT SIGNAL<br/>(NOT APPLICABLE FOR<br/>2/3 POINTS)</b> | 1 = 0(2)...10 VDC and<br>0(4)...20 mA             |            |
|   | 2 = 0(2)...10 VDC only                            |            |
|   | 3 = 0...135 Ω only                                |            |
|   | 4 = 4...20 mA only                                |            |
| <b>TORQUE</b>   | 02 = 2 Nm   | 03 = 3 Nm  |
|   | 05 = 5 Nm   | 08 = 8 Nm  |
|   | 10 = 10 Nm  | 15 = 15 Nm |
|   | 20 = 20 Nm  | 40 = 40 Nm |
|   | None = No Auxiliary or<br>Feedback Potentiometers |            |
| <b>AUXILIARY SWITCH<br/>/ FEEDBACK<br/>POTENTIOMETER</b>    | S1 = 1 x Auxiliary Switch                         |            |
|   | S = 2 x Auxiliary Switches                        |            |
|   | P1 = 1000Ω  |            |
|   | P2 = 10000Ω                                       |            |
| P3 = 140Ω   |   |            |

# SAFA SERIES FIRE & SMOKE DAMPER ACTUATOR

2 Point Spring Return Control  
8 Nm

## SAFA...08S (T) SERIES

SAFA series Spring Return damper actuators are designed specifically for fire and smoke application. During normal operation, the actuator motorized the damper. In the event of fire emergency, the actuator springs back to its original position when there is power outage or trip by thermal sensor.



## PRODUCT FEATURE

- Torque 8 Nm
- Damper size 1.5 m<sup>2</sup>
- Power supply AC/DC 24V and AC 230 V
- Shaft dimensions - Form fit 12 mm square
- Adapter supplied for Form fit 8 or 10 mm square
- Selectable direction of rotation
- Actuator with 1 m cable connection
- 2 Fixed auxiliary switches (SPDT)
- Manual Over-ride by crank handle when required
- Thermal sensor option available
- Anti-rotation bracket provided for stability

## MODEL SELECTION TABLE

| MODEL / TYPE | TORQUE | POWER SUPPLY     | RUNNING TIME                         | AUXILIARY SWITCHES  | THERMAL SENSOR |
|--------------|--------|------------------|--------------------------------------|---------------------|----------------|
| SAFA 1-08S   | 8 Nm   | AC/DC 24 V ± 10% | 75...90 sec<br>(Spring Back <25 sec) | 2 x SPDT<br>(Fixed) | -              |
| SAFA 1-08ST  | 8 Nm   | AC/DC 24 V ± 10% | 75...90 sec<br>(Spring Back <25 sec) | 2 x SPDT<br>(Fixed) | Yes            |
| SAFA 2-08S   | 8 Nm   | AC 230 V ± 10%   | 75...90 sec<br>(Spring Back <25 sec) | 2 x SPDT<br>(Fixed) | -              |
| SAFA 2-08ST  | 8 Nm   | AC 230 V ± 10%   | 75...90 sec<br>(Spring Back <25 sec) | 2 x SPDT<br>(Fixed) | Yes            |

## DIMENSION (mm)

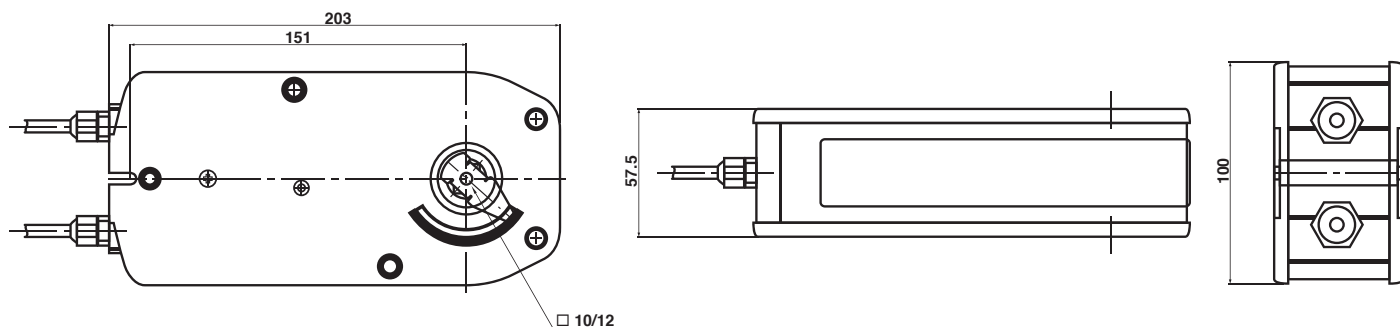

## TECHNICAL SPECIFICATION

| MODEL NUMBER              | SAFA 1-08S (T)                  | SAFA 2-08S (T)                  |
|---------------------------|---------------------------------|---------------------------------|
| TORQUE                    | 8 Nm                            | 8 Nm                            |
| DAMPER SIZE               | 1.5 m <sup>2</sup>              | 1.5 m <sup>2</sup>              |
| SHAFT DIMENSION           | Form fit 12 mm square           | Form fit 12 mm square           |
| POWER SUPPLY              | AC/DC 24 V ± 10%                | AC 230 V ± 10%                  |
| FREQUENCY                 | 50...60 Hz                      | 50...60 Hz                      |
| CONTROL SIGNAL            | 2 point control                 | 2 point control                 |
| POWER CONSUMPTION         |                                 |                                 |
| ● OPERATING               | 2.0 W                           | 2.0 W                           |
| ● END POSITION            | 10.0 W                          | 10.0 W                          |
| FOR WIRE SIZING           | 10.0 VA                         | 10.0 VA                         |
| ELECTRICAL CONNECTION     | 1 m Cable                       | 1 m Cable                       |
| AUXILIARY SWITCHES RATING | 3 (1.5) A, AC 250 V             | 3 (1.5) A, AC 250 V             |
| PROTECTION CLASS          | Class III ⚡                     | Class II ⚡                      |
| ANGLE OF ROTATION         | 90° (95° mechanical)            | 90° (95° mechanical)            |
| THERMAL TEMPERATURE TRIP  | > 72°C                          | > 72°C                          |
| WEIGHT                    | 2.2 Kg                          | 2.3 Kg                          |
| LIFE CYCLE                | 60,000 Rotation                 | 60,000 Rotation                 |
| SOUND LEVEL               | 40 dB                           | 40 dB                           |
| IP PROTECTION             | IP54                            | IP54                            |
| OPERATING TEMPERATURE     | -20°...50° as per IEC 721-3-3   | -20°...50° as per IEC 721-3-3   |
| NON-OPERATING TEMPERATURE | -30°...+60° C / IEC 721-3-2     | -30°...+60° C / IEC 721-3-2     |
| AMBIENT HUMIDITY          | 5%...95% rH non condensing / EN | 5%...95% rH non condensing / EN |
| MAINTENANCE               | Maintenance Free                | Maintenance Free                |
| MODE OF OPERATION         | Type I / EN 60730-1             | Type I / EN 60730-1             |
| EMC                       | CE, UL 873 & ISO 9000 EN / EEC  | CE, UL 873 & ISO 9000 EN / EEC  |

# SAFA SERIES FIRE & SMOKE DAMPER ACTUATOR

2 Point Spring Return Control  
8 Nm

## WIRING DIAGRAM SAFA...08S (T) POWER SUPPLY AC/DC 24 V / AC 230V

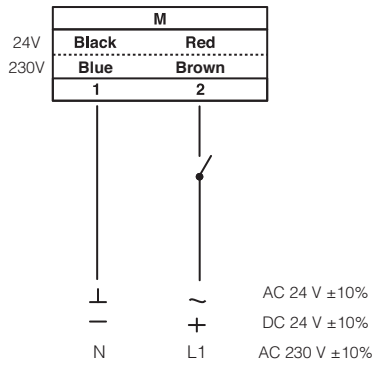

## DIRECTION OF ROTATION SAFA...08S (T)

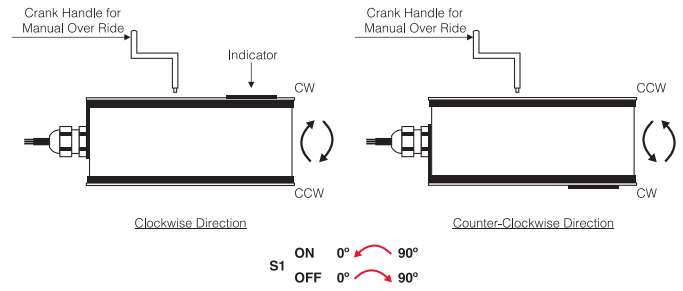

## WIRING DIAGRAM SAFA...08S (T) AUXILIARY SWITCHES

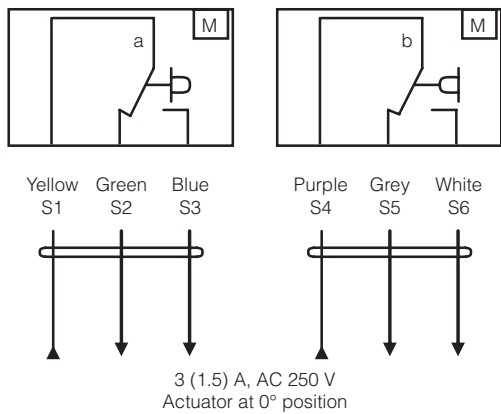

## AUXILIARY SWITCHES SAFA...08S (T)

Auxiliary are fixed at 5° for switch (a) and 85° for switch (b)  
Auxiliary switches are non adjustable.

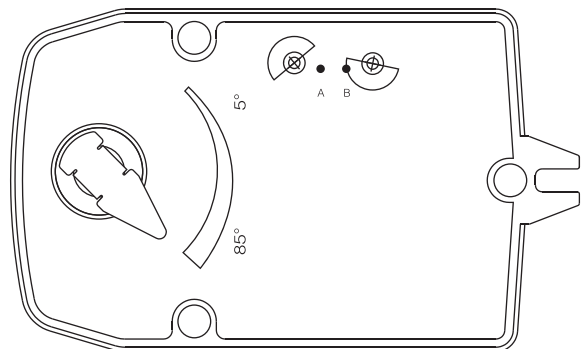

## THERMAL SENSOR NTS72

Thermal Sensor NTS 72 consist of both Ambient (TS1) and Duct sensor (TS2).

- TS1 will trip open when the ambient temperature rise above 72°.
- TS2 will trip open when the duct temperature rise above 72°.

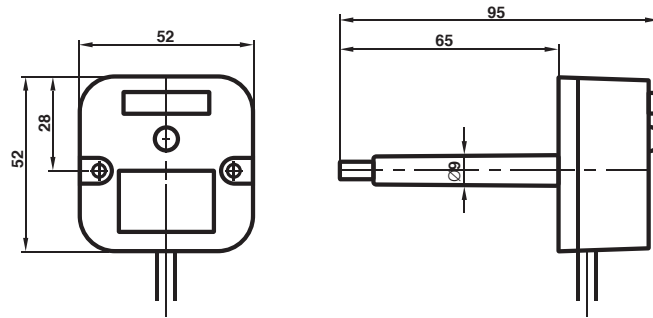

## INSTALLATION / MOUNTING INSTRUCTION

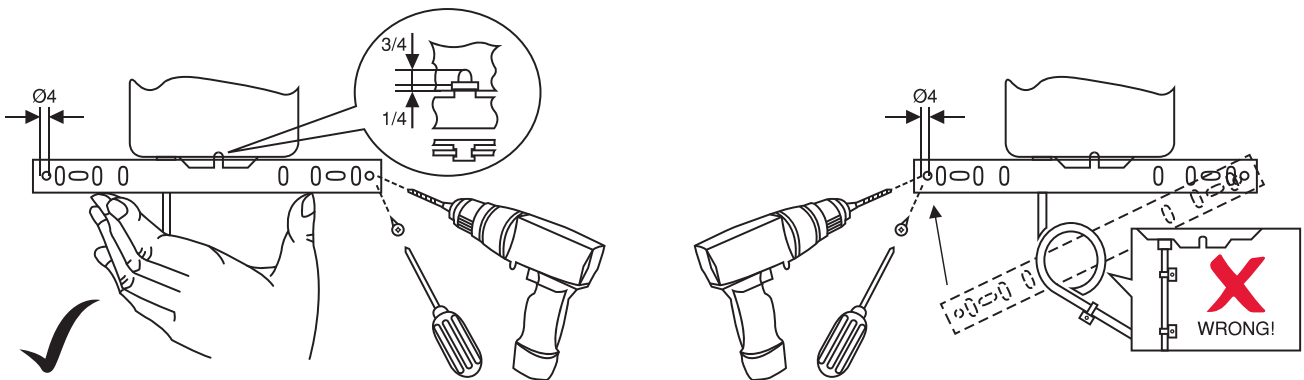

## OEM CUSTOMISED VERSION ON REQUEST

Nenutec offers you actuators in customised version, e.g. with your own brand name, with colour-coordinated applications and with your particular demand. Please contact us for further information.

## IMPORTANT REMARK

For special requirement, consult your local Nenutec's representative.



This actuator includes electrical and electronic components and may not be disposed as household garbage. Please consider the local valid legislation.

AC / DC 24 V: Connect via safety isolating transformer.  
AC 230 V: To isolate from the main power supply, the system must incorporate a device which disconnects the phase conductor (with at least a 3mm contact gap.)

The performance specifications are nominal and conform to acceptable industry standards. Nenutec shall not be liable for damages resulting from misapplication or misuse of its products.